

Project	Quantity	Item #
Model Specified:		CSI Section 11400

Compact Sandwich Prep Tables with Raised Cover/Self-Contained



Model UPT4812

27", 32", 48", 60" & 72" Wide Models



Stainless Exterior,
Anodized Aluminum
Interior

27" Wide 6 Pan Model	UPT276
27" Wide 9 Pan Model	UPT279
32" Wide 8 Pan Model	UPT328
32" Wide 12 Pan Model	UPT3212
48" Wide 8 Pan Model	UPT488
48" Wide 12 Pan Model	UPT4812
48" Wide 18 Pan Model	UPT4818
60" Wide 12 Pan Model	UPT6012
60" Wide 24 Pan Model	UPT6024
72" Wide 12 Pan Model	UPT7212
72" Wide 18 Pan Model	UPT7218
72" Wide 24 Pan Model	UPT7224
72" Wide 30 Pan Model	UPT7230

Traulsen's durable, high performance, sandwich prep tables provide a high quality/high value alternative to the all too common commodity types in today's market.

Any comparison between prep tables should start with performance, and Traulsen really does the job. Not only do they all meet the NSF 7 Standard, but do so under real world conditions, even when using 6" deep pans! A Traulsen exclusive.

Truly front breathing, their design allows for "zero-clearance" installation. As a result they can be placed right up against the backwall and alongside other kitchen equipment, saving valuable floor space.

Standard Product Features

- High Quality Stainless Steel Exterior Top, Sides & Door(s)
- Durable, Corrosion Resistant Anodized Aluminum Interior
- Provides NSF Standard 7 Performance, Even When Using 6" Deep Pans - A Traulsen Exclusive
- Front Breathing Self-Contained Refrigeration System
- Standard Work Height 36-1/4" (see "optional accessory kits for lower height casters to meet ADA requirements or provide lower work heights)
- Environmentally Friendly R-134a Refrigerant
- Top Cut-Outs Accommodate Sixth Size Pans (divider bars and 4" deep plastic sixth size pans provided)
- Reinforced Pan Ledge (holds pans securely level)
- Removable Stainless Steel Insulated Pan Cover & Pivoting Front Lid
- Reversible, Full Length White Nylon Cutting Board
- Self-Closing Stainless Steel Doors With Convenient Stay Open Feature @ 105 Degrees
- Metal Door Handles
- Anodized Aluminum Interior Door Liners
- Interior Mounted Thermometer
- Two (2) Powder Coated Steel Shelves Per Door, Mounted On Adjustable Pilasters
- Automatic Non-Electric Condensate Evaporator
- Magnetic Snap-In EZ-Clean Door Gasket(s)
- 8' Cord & Plug Attached
- Set of Four (4) 4" Casters (6 for 60" & 72" models)
- Three Year Parts And Labor Warranty
- Five Year Compressor Warranty

Optional Accessory Kits*

- CASTER 5SET4 (four 6" high casters for 27", 32" & 48" models)
- CASTER 5SET6 (six 6" high casters for 60" & 72" models)
- CASTER SET3IN (four 3-1/2" high casters for 27", 32" & 48" models)
- CASTER SET4 (six 3-1/2" high casters for 60" & 72" models)
- CASTER SET2IN (four 2-1/2" high casters for 27" models)
- SHELF CPW1 (additional shelf for all 27" models)
- SHELF CPW2 (additional shelf for all 32" models)
- SHELF48 UPPER (upper shelf for all 48" models)
- SHELF48 LOWER (lower shelf for all 48" models)
- SHELF60 UPPER (upper shelf for all 60" models)
- SHELF60 LOWER (lower shelf for all 60" models)
- SHELF72 UPPER (upper shelf for all 72" models)
- SHELF72 LOWER (lower shelf for all 72" models)

*All optional accessory kits are shipped separately for field installation.

Factory Installed Options

- Stainless Steel Finished Back
- Other Door Hinges



This unit is listed to UL 471, CSA 120 and NSF 7 by an approved NRTL. Consult the factory or unit data plate for approval information.



Approval: _____



TRAULSEN
4401 BLUE MOUND RD.
PHONE 1 (800) 825-8220
Website: www.traulsen.com

FT. WORTH, TX 76106
FAX-MKTG. 1 (817) 624-4302

Project

Quantity

Item #

Model Specified:

CSI Section 11400

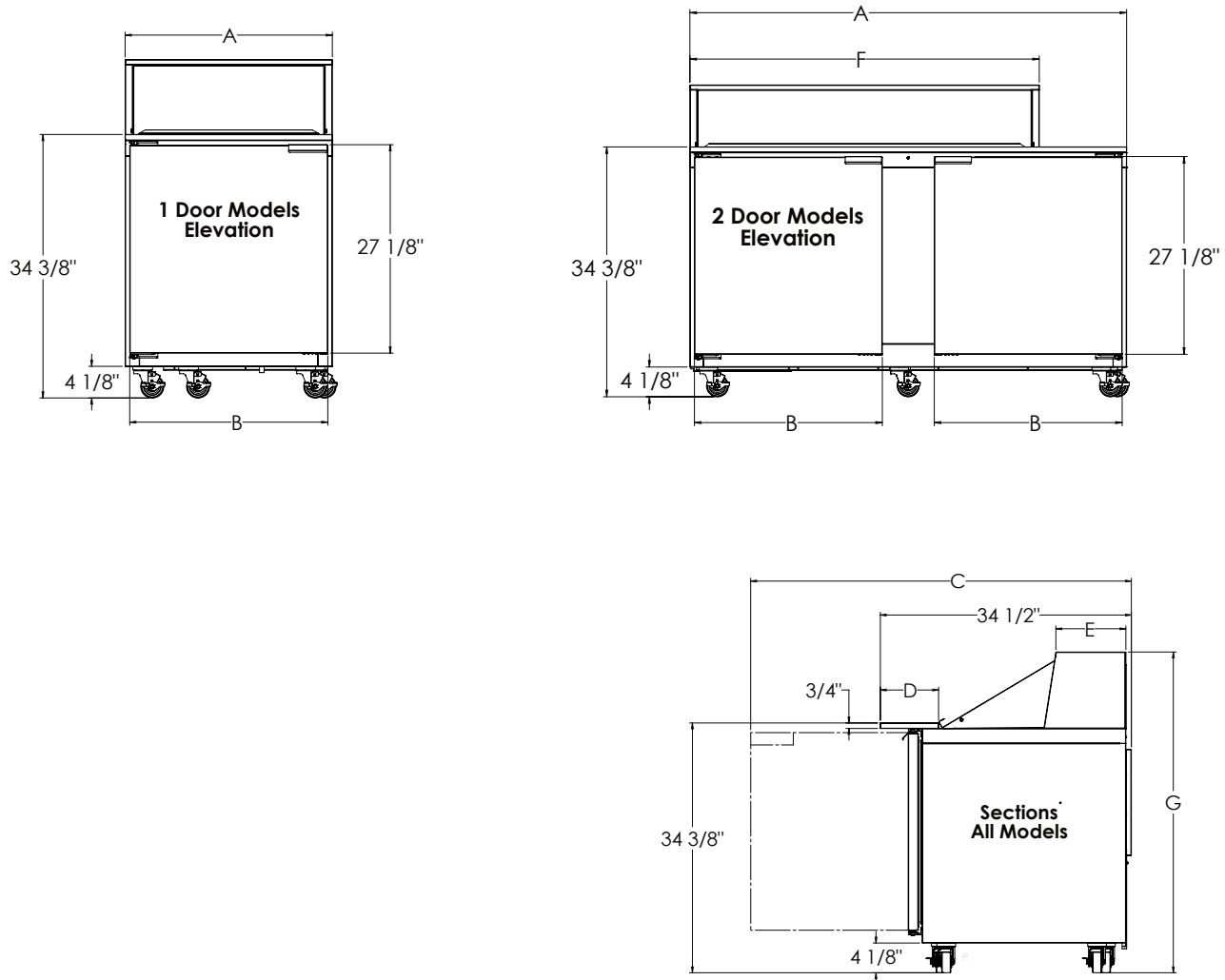

Cabinet Dimensional Data													
Model	Storage cu. ft.	# of 1/6 Size Pans Top	Width - cabinet	Width - door	Depth - door open 90°	Depth-Cutting Board	Depth-Lid Top	Width-Pan Cover Lid	Height-Overall (mounted on 4" casters)	Clear Door Opening	# of doors	# of shelves	Total shelf area sq. ft.
UPT276	7.7	6	27"	24 5/8"	25 7/8"	12"	9 3/8"	27"	42 3/4"	22 3/4"	1	2	4.88
UPT279	7.7	9	27"	24 5/8"	25 7/8"	8"	9 5/8"	27"	44"	22 3/4"	1	2	4.88
UPT328	9.3	8	32"	29 5/8"	30 13/16"	12"	9 3/8"	32"	42 3/4"	27 3/4"	1	2	6.13
UPT3212	9.3	12	32"	29 5/8"	30 13/16"	8"	9 5/8"	32"	44"	27 3/4"	1	2	6.13
UPT488	14.0	8	48"	21 1/8"	21 1/8"	12"	9 3/8"	36 1/2"	42 3/4"	18"	2	4	10.3
UPT4812	14.0	12	48"	21 1/8"	21 1/8"	12"	9 3/8"	48"	42 3/4"	18"	2	4	10.3
UPT4818	14.0	18	48"	21 1/8"	21 1/8"	8"	9 5/8"	48"	44"	18"	2	4	10.3
UPT6012	18.2	12	60"	24 5/8"	25 7/8"	12"	9 3/8"	48"	42 3/4"	22 3/4"	2	4	13.2
UPT6024	18.2	24	60"	24 5/8"	25 7/8"	8"	9 5/8"	60"	44"	22 3/4"	2	4	13.2
UPT7212	24.5	12	72"	29 5/8"	25 7/8"	12"	9 3/8"	48"	42 3/4"	27 3/4"	2	4	15.5
UPT7218	24.5	18	72"	29 5/8"	30 13/16"	8"	9 5/8"	48"	44"	27 3/4"	2	4	15.5
UPT7224	24.5	24	72"	29 5/8"	30 13/16"	8"	9 5/8"	60"	44"	27 3/4"	2	4	15.5
UPT7230	24.5	30	72"	29 5/8"	30 13/16"	8"	9 5/8"	72"	44"	27 3/4"	2	4	15.5

Project

Quantity

Item #

Model Specified:

CSI Section 11400

Top Pan Configuration

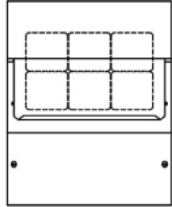

UPT276 Model

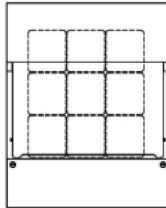

UPT279 Model

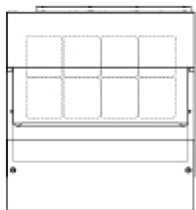

UPT328 Model



UPT3212 Model

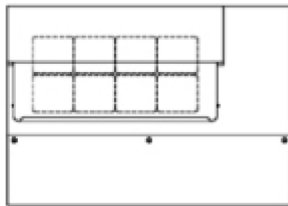

UPT488 Model

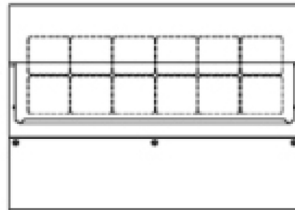

UPT4812 Model

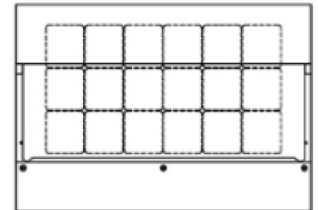

UPT4818 Model

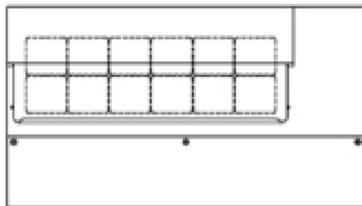

UPT6012 Model

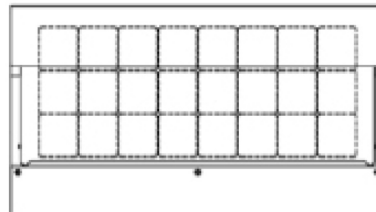

UPT6024 Model

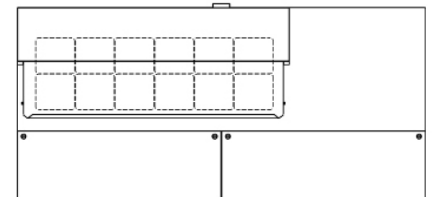

UPT7212 Model

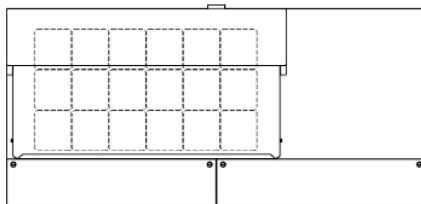

UPT7218 Model

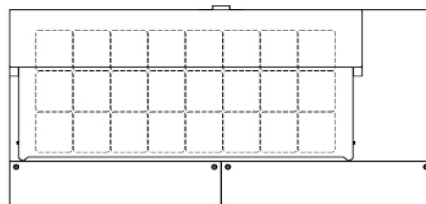

UPT7224 Model

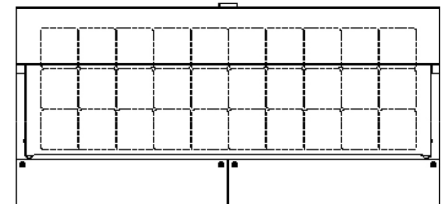

UPT7230 Model



TRAULSEN
4401 BLUE MOUND RD.
PHONE 1 (800) 825-8220
Website: www.traulsen.com

FT. WORTH, TX 76106
FAX-MKTG. 1 (817) 624-4302

Project	Quantity	Item #
Model Specified:		CSI Section 11400

Specifications

Construction, Hardware and Insulation

Cabinet exterior front, sides, pan cover, lid and doors are constructed of stainless steel. Cabinet interior and door liners are constructed of anodized aluminum. The exterior cabinet back and bottom are constructed of galvanized steel.

Doors self close at less than 90 degrees and also includes a stay open feature at 105 degrees. Gasket profile and Santoprene® material simplify cleaning and increase overall gasket life.

Both the cabinet and doors are insulated with an average of 2" thick high density, non-CFC, foamed in place polyurethane.

A 3/4" thick, full-length, reversible white nylon cutting board is supplied standard.

Pans & Cover

Each model is supplied standard with its full compliment of 4" deep plastic 1/6 size pans and stainless steel pan dividers. The pan cover and lid are constructed of stainless steel, and is easily removable for cleaning.

Refrigeration System

A balanced, rear mounted, front breathing, self-contained refrigeration system using R-134a refrigerant is provided. It features a capillary tube metering device, air-cooled hermetic compressor, a forced air evaporator coil and a non-electric condensate evaporator. An 8' cord and plug is provided. Standard operating temperature of the refrigerated base is 34 to 38°F.

Interior

Standard interior arrangements include two (2) powder coated wire shelves per door, mounted on pilasters. These are adjustable in 1/2" increments, allowing for a minimum of 1-1/2" spacing between shelves.

Warranties

Both a three year parts and labor warranty and a five year compressor warranty (self-contained models only) are provided standard.

Eletrical & Refrigeration Data			Shipping Data		
115/60/1 R-134a NEMA 5-15P			(42"D x 56"H)		
Model	Full Load Amps	BTU/HR - HP	Width - crated	Volume - crated cu. ft.	Weight - lbs.
UPT276	7.5	1390 (1/4)	45"	45	376 net/425 gross
UPT279	7.5	1390 (1/4)	45"	45	376 net/425 gross
UPT328	7.5	1390 (1/4)	45"	45	255 net/300 gross
UPT3212	7.5	1390 (1/4)	45"	45	255 net/300 gross
UPT488	7.5	1390 (1/4)	69"	69	355 net/400 gross
UPT4812	7.5	1390 (1/4)	69"	69	355 net/400 gross
UPT4818	7.5	1390 (1/4)	69"	69	355 net/400 gross
UPT6012	7.5	1390 (1/4)	69"	69	457 net/500 gross
UPT6024	7.5	1390 (1/4)	69"	69	457 net/500 gross
UPT7212	7.5	1390 (1/4)	84"	84	548 net/575 gross
UPT7218	7.5	1390 (1/4)	84"	84	548 net/575 gross
UPT7224	7.5	1390 (1/4)	84"	84	548 net/575 gross
UPT7230	7.5	1390 (1/4)	84"	84	548 net/575 gross

NOTES:

- Overall depth figure includes standard cutting board.
- Height shown when mounted on 6" high legs or casters.
- Based on a 90 degree F ambient and 20 degree F evaporator.
- When ordering please specify: Voltage, Hinging, Optional Accessories and any additional warranties.
- This unit may be manufactured in other electrical characteristics and may have additional regulatory agency approvals. Consult factory for other electrical characteristics and agency approvals based on specific electrical and country requirements. (For exact electrical information and approval marks, always refer to the data label of the unit.)
- Continued product development may necessitate specification changes without notice.

Part No. TR35822 (revised 02-05-16)

TRAULSEN
4401 BLUE MOUND RD.
PHONE 1 (800) 825-8220
Website: www.traulsen.com

FT. WORTH, TX 76106
FAX-MKTG. 1 (817) 624-4302

